

Chapter 5

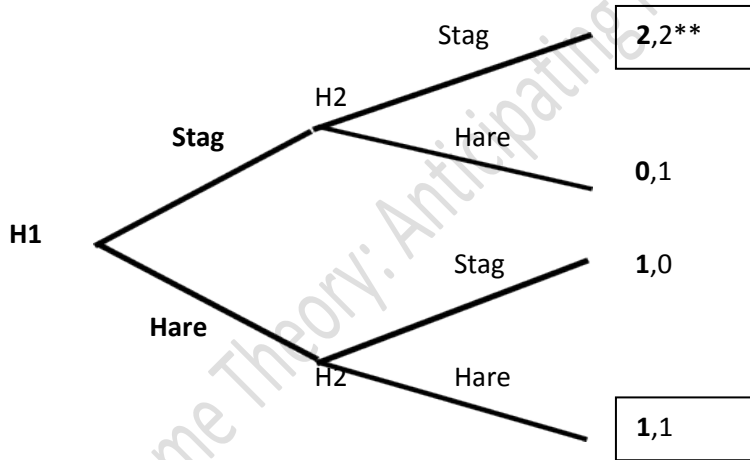

From Game Theory: Anticipating Reactions by Mark L. Burkey

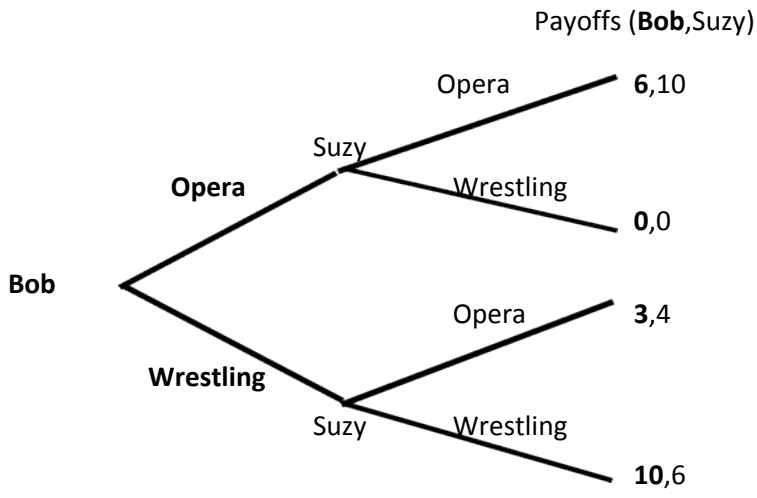
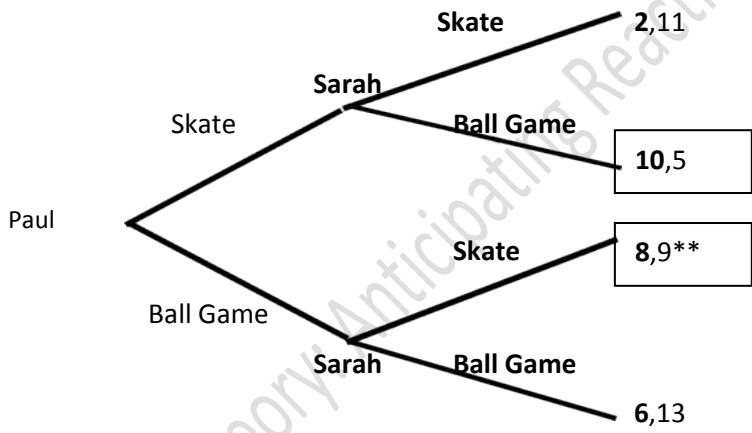
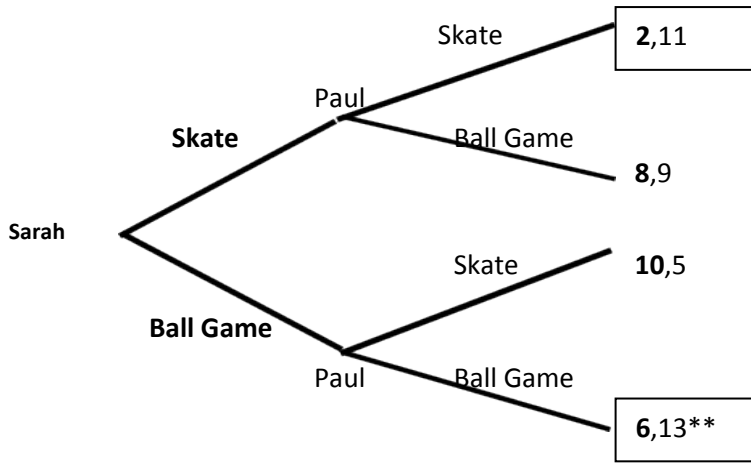

From Game Theory: Anticipating Reactions by Mark L. Burkey

	Column		
Row		L	R
	U		<u>10,7</u>
D		<u>9,11</u>	<u>3,9</u>

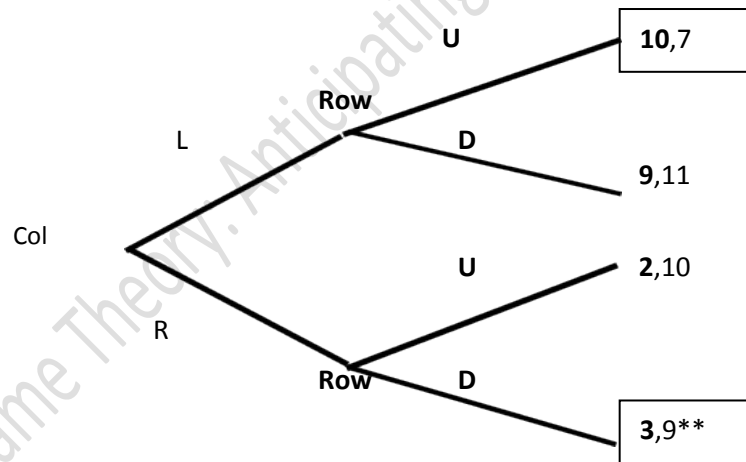
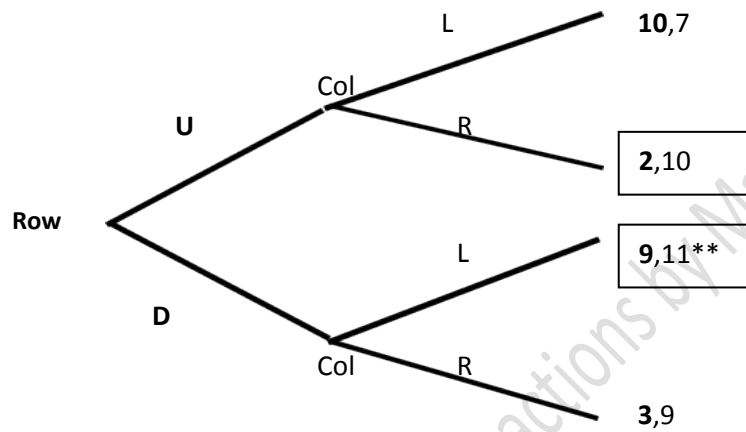

From Game Theory: Anticipating Reactions by Mark L. Burkey

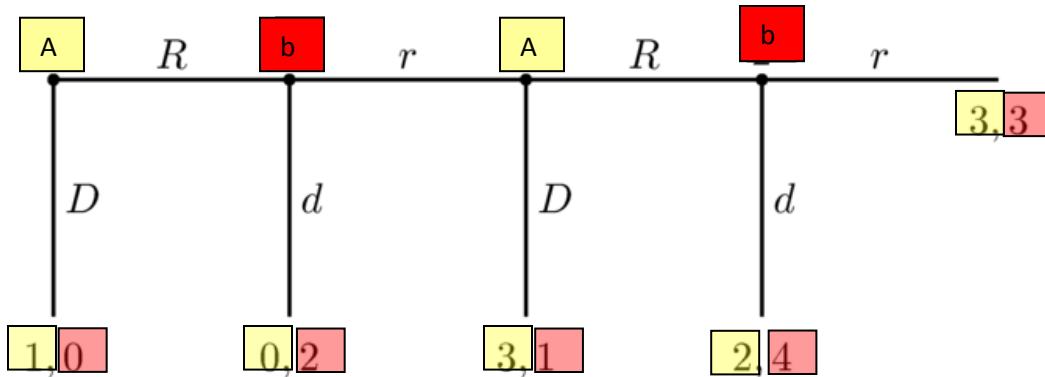

Original Image Source is Wikipedia, CC Attribution Share Alike 3.0 Unported License

http://en.wikipedia.org/wiki/File:Centipede_game.png#filelinks

From Game Theory: Anticipating Reactions by